

PRODUCTS PICTURED:
LINEAR REFRESH CHAIR

TEXTILES PICTURED:
VARSITY
LINETTE



2024 FULL LINE CATALOG

AT OUR CORE

WE ARE COMMITTED TO

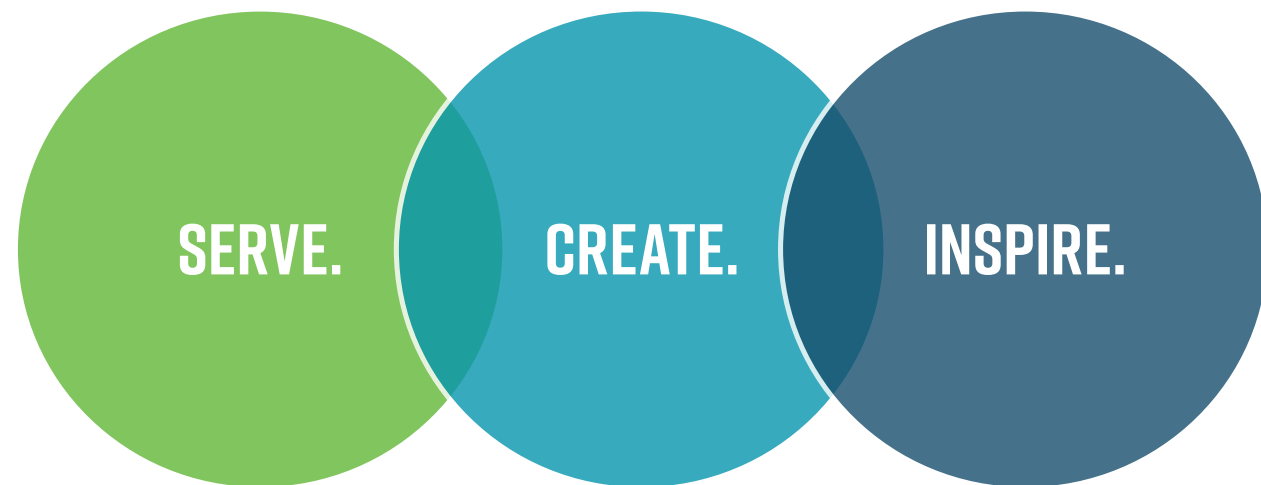

AND OUR MISSION IS TO **BLESS OTHERS** 



WE SERVE OUR PEOPLE AND CUSTOMERS BY INSPIRING HEALTHY, SAFE, AND ADAPTABLE ENVIRONMENTS THAT CREATE SPACE FOR EVERYONE TO **CONNECT AND BELONG.**

Soft seating is all we do, and foam is all we do it with. It's what makes us the foam experts! Our expertise in foam is unmatched, and we take pride in our unique single-cut foam construction that not only makes our furniture more sustainable and cost-effective but also ensures its durability under high usage. With hundreds of color options in fabrics and vinyl, as well as other finishing options, you can be sure our furniture will fit your unique needs. No other company creates quality, stylish, comfortable soft seating backed by a lifetime warranty* like we do at Fōmcore. Give us a chance to prove ourselves and experience the transformation Fōmcore soft seating can bring to your space.



CONTENTS

AT OUR CORE	1 - 2
IT'S ALL IN THE DETAILS	3 - 4
OTTOMAN & BENCH SERIES	5 - 6
ARMLESS SERIES	7 - 8
CONNECT SERIES	9 - 10
CAFÉ SERIES	11
SOCIAL SERIES	12
NEST SERIES	13 - 14
STEP SERIES	15
NETWORK SERIES	16
LOTUS SERIES	17 - 18
WEATHER RESISTANT SERIES	19 - 20
CREATE YOUR COMBO	21 - 22
FŌM FILLED SERIES	23
MATERIAL SWATCHES	24 - 26
MODIFICATIONS	27 - 28
DESIGN SERVICES	29 - 30
AT A GLANCE	31 - 32
WHY FOAM?	33 - 34
PRODUCT REFERENCE GUIDE	35 - 61
POWER REFERENCE GUIDE	63 - 64
CUSTOMER SERVICE	65 - 66

 **2024 NEW PRODUCT**



PRODUCTS PICTURED:
LILY PAD
TEXTILES PICTURED:
MICRO DOT

LEARN MORE ABOUT WHO WE ARE AND OUR CORE VALUES #ATOURCORE



SCAN or CLICK ME

*See page 65 for lifetime warranty details.

IT'S ALL IN THE DETAILS

SO MUCH MORE THAN JUST AN OTTOMAN

CUSTOMIZATION VS. MODIFICATION

CUSTOMIZATION

- Work with our design and engineering team to create a completely custom design
- Create or design any shape, even abstract (ex. dolphin, airplane, star, etc.)
- Typically, there is no extended lead time for custom orders once the drawings have been approved

MODIFICATION

- Modify any of our standard pieces by altering the height or width
**In many cases there is no additional charge to make this change.*
- Other modifications available:
 - Thread/zipper color
 - Glides, legs, casters
 - Power options
 - TFL work surface
 - Embroidery
 - Weather resistant
 - Textile option and placement



CUSTOM PIECE



MODIFIED PIECE

CONSTRUCTION

- Solid foam construction means there is no internal wood frame
- Foam fabrication is done in-house with 600lb buns of foam
- Each product is sewn with double seams to ensure the strength and integrity
- Marine grade nylon thread is not only strong, but it also holds up to both light and moisture
- The rounded edge on our wood base protects the textile from cracking or ripping
- With each shipment, you receive a custom-made Klever Cutter to cut open packaging - not your product
- Machines are not creating our product - people are! We have a robust training program to ensure each team member is a true craftsman in their department
- All promoted textiles are tested and approved for use
- Engineers are in-house and hands-on; they develop and test products to make sure they meet BIFMA standards
- Our precision cutting equipment allows for endless shapes, sizes, and customization
- We stand behind our products with a lifetime warranty* See page 65 for details



TEXTILES PICTURED:
SILICA JIG
CRISSCROSS



WHERE OUR PRODUCTS FIT

- **K-12**
 - Classroom
 - Playground
 - Cafeteria
 - Library
 - Computer Lab
 - Administration
 - Spaces in Between
- **HEALTHCARE**
 - Reception
 - Waiting Room
 - Pediatric
 - Café
 - Consultation Space
 - Self Care
 - Spaces in Between
- **HIGHER EDUCATION**
 - Library
 - Residence Hall
 - Dorm Room
 - Dining Hall
 - Administration
 - Lecture Hall
 - Student Union
 - Computer Lab
 - Career Services
 - Communal Study Spaces
 - Spaces in Between
- **COMMERCIAL**
 - Office
 - Breakroom
 - Lounge
 - Work Space
 - Collaborative Space
 - Conference Room
 - Lobby
 - Outdoor Space
 - Café
 - Spaces in Between

ZIPPERED VS. UPHOLSTERED

ZIPPERED

- Solid foam construction
- No wood base
- No pinch points
- Zipper sealed from the inside, so fabric won't come undone
- Can be utilized in multiple ways

UPHOLSTERED

- Solid foam construction
- Upholstered to wood base with rounded edges to protect textile
- High-quality black fabric with black staples to cover the bottom
- Allows for the modification of legs, glides, casters, and power

ZIPPERED



UPHOLSTERED



PRODUCTS PICTURED:
BUMP BENCH
ANDERSON CHAIR
LILY PAD

TEXTILES PICTURED:
BAYSIDE
LARA

CHECK OUT OUR
BE INSPIRED PAGE
TO SEE MORE



SCAN or CLICK ME

OTTOMAN & BENCH SERIES

The Ottoman and Bench Series takes flexible seating to the next level. With a lightweight, solid foam structure, it's easy to create exactly what you need. Whether you are looking to create a personal space or collaborative environment, you can do it quickly and efficiently with pieces from the Ottoman and Bench Series.



TEXTILES PICTURED:
EVO
SIVERTEX

OTTOMANS

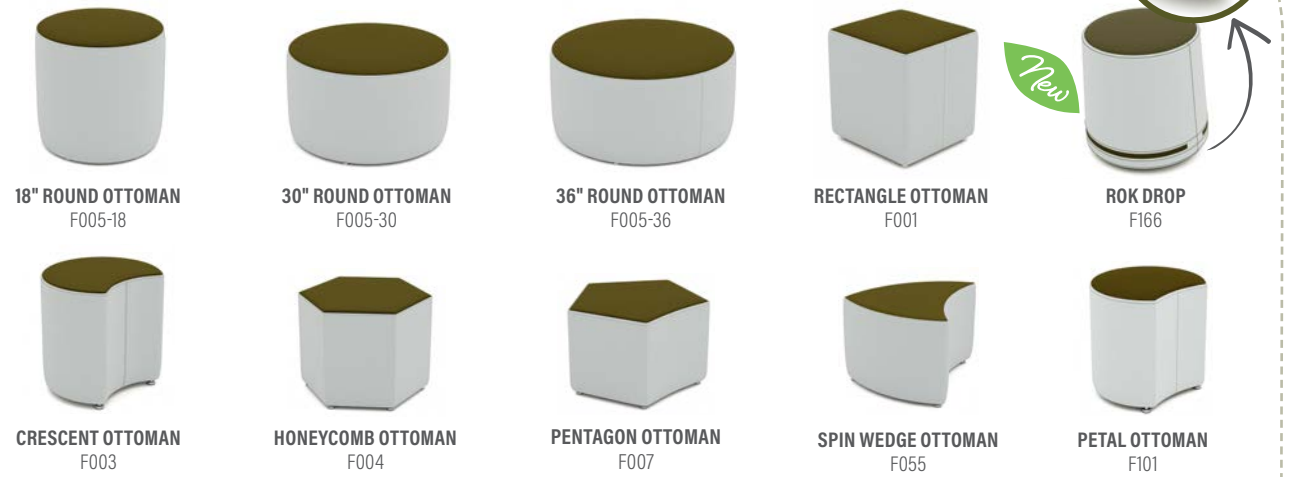

ROK Drop is fully foam, has a non-slip base, and comes in 2 heights.

New

NEW DESIGN

IDEA STARTERS

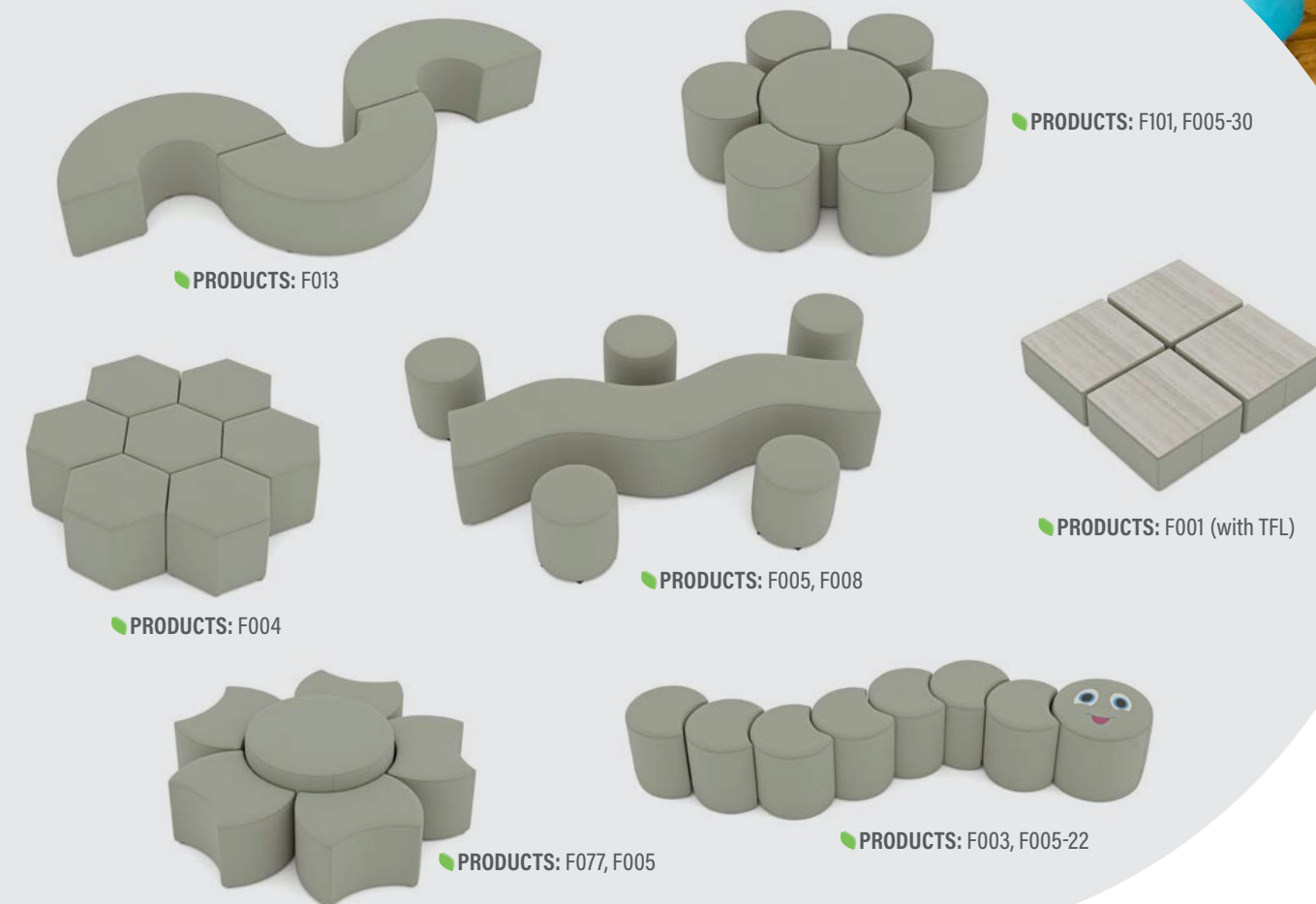

BENCHES

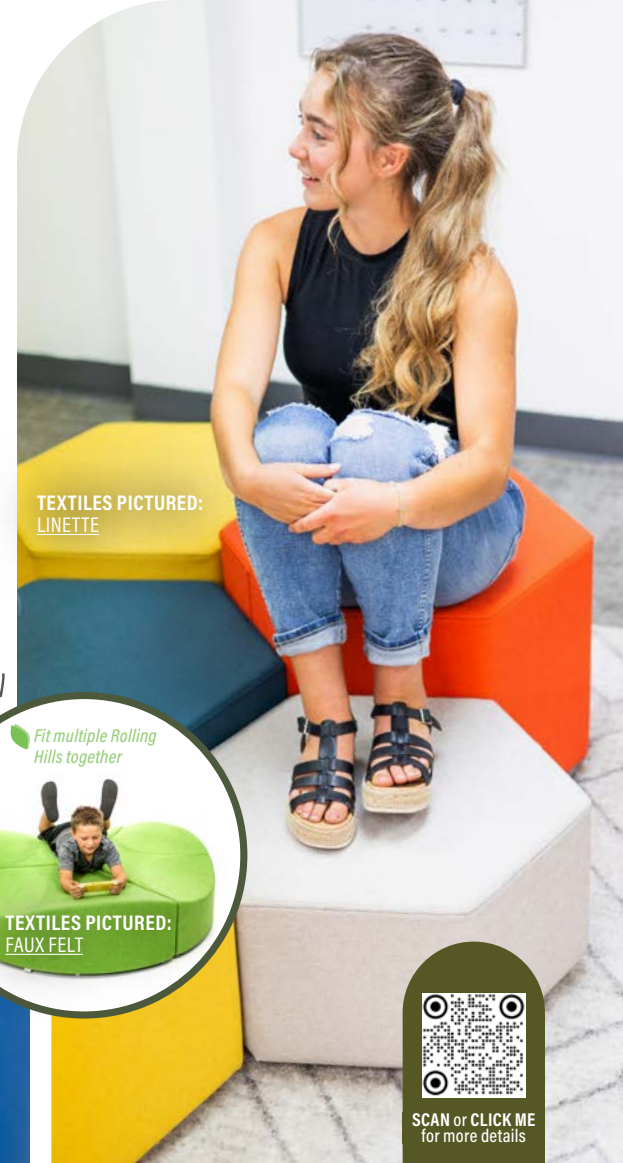
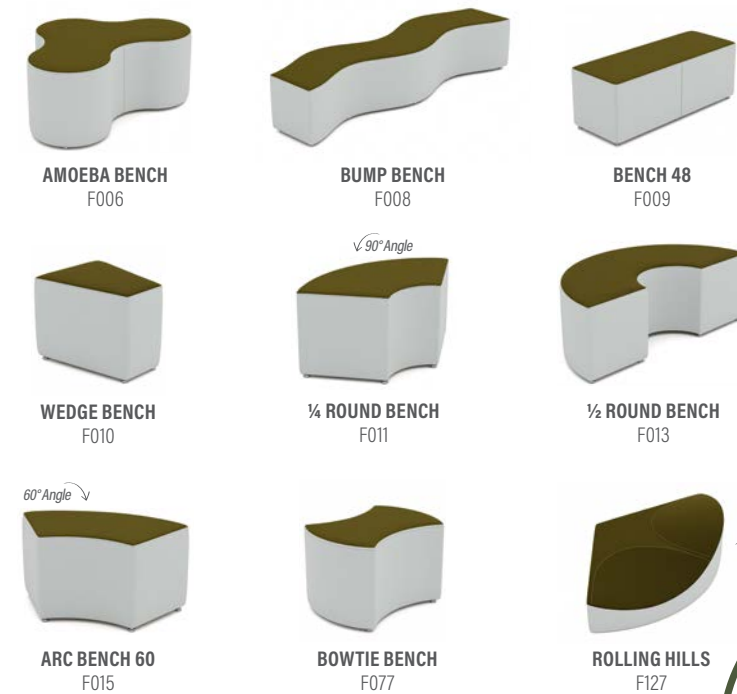

TEXTILES PICTURED:
LINETTE

Fit multiple Rolling Hills together

TEXTILES PICTURED:
FAUX FELT

See the Fomcore craftsmanship up close. Our standard practice is to match the thread to the seat color of the furniture, however you can choose a different thread at no extra charge.

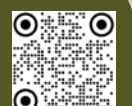

SCAN or CLICK ME for more details

ARMLESS SERIES

Cultivate creativity and engage the senses with endless possibilities of combinations utilizing all the pieces in the Armless Series. With a waterfall edge and lightweight structure, mix and match multiple pieces to form serpentine, circles, sectional seating, or any other design you can imagine as you create the perfect environment.



TEXTILES PICTURED:
VARSITY
LINETTE
BIG DOT



TEXTILES PICTURED:
TRIVIA
SIVERTEX

ARMLESS SERIES

IDEA STARTERS



PRODUCTS: F005-36, F020, F106



PRODUCTS: F005-30 (with TFL), F019, F061, F016, F062

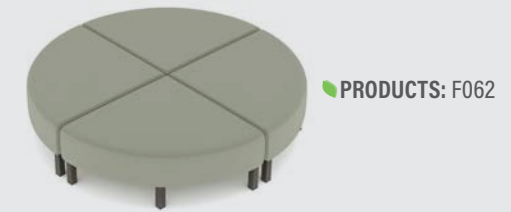

PRODUCTS: F062



PRODUCTS: F139, F141, F001 (with TFL)

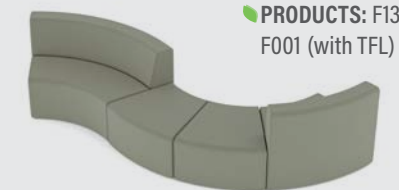

PRODUCTS: F020, F108, F018



SCAN or CLICK ME for more details

CURVED ARMLESS

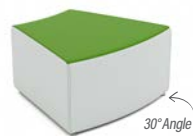

CURVED BENCH 30
F108

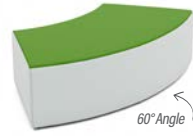

CURVED BENCH 60
F106



CURVED LOVESEAT
F018



CURVED SOFA IN
F020



CURVED OUTSIDE SOFA 40
F109



ARMLESS CURVED CORNER
F061



TEXTILES PICTURED:
BANDWIDTH
EVO

LINEAR REFRESH



LINEAR REFRESH CHAIR
F139



LINEAR REFRESH LOVESEAT
F140



LINEAR REFRESH SOFA
F141



LINEAR REFRESH OTTOMAN
F142



LINEAR REFRESH BENCH
F143

LINEAR ARMLESS



LINEAR CORNER
F024



LINEAR LOVESEAT
F017



LINEAR SOFA
F019



LINEAR CHAIR
F016



LINEAR WEDGE
F062



LINEAR OTTOMAN
F107

TEXTILES PICTURED:
LARA
PING PONG

FOR PRODUCT DETAILS SEE PAGES 39-43

TEXTILES PICTURED:
VARSITY
LINETTE



IDEA STARTERS

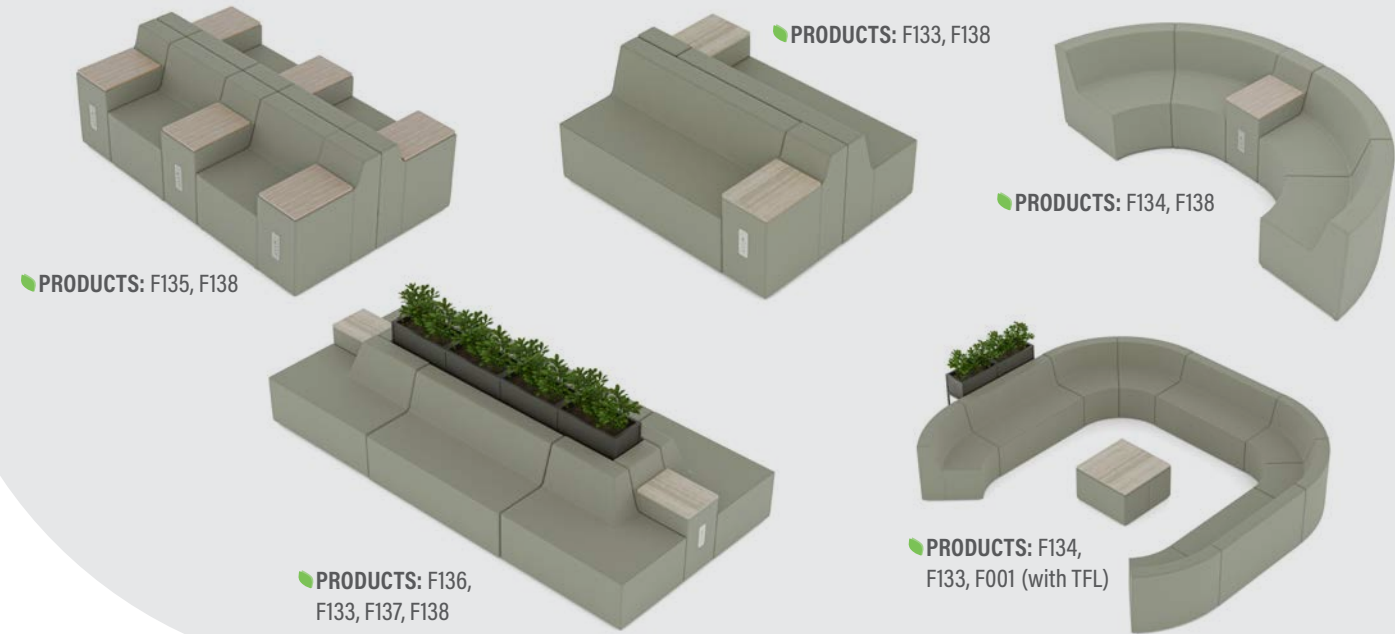

CONNECT SERIES

Create. Collaborate. Connect. The Connect Series inspires creativity and collaboration in a variety of environments. Whether you're looking for flexible seating to add to a conference room or a classroom, this set can be arranged to make countless formations. With our lightweight, solid foam construction, the Connect Series can be easily maneuvered to create a collaborative space for any environment.

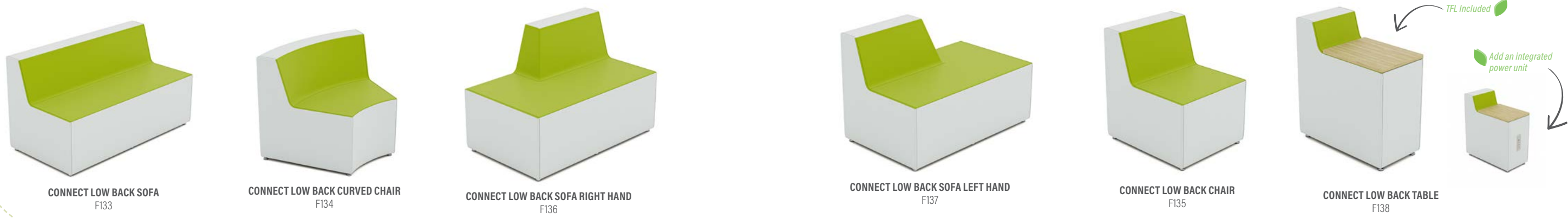

TEXTILES PICTURED:
LARA
ALPHABET
POLYGON

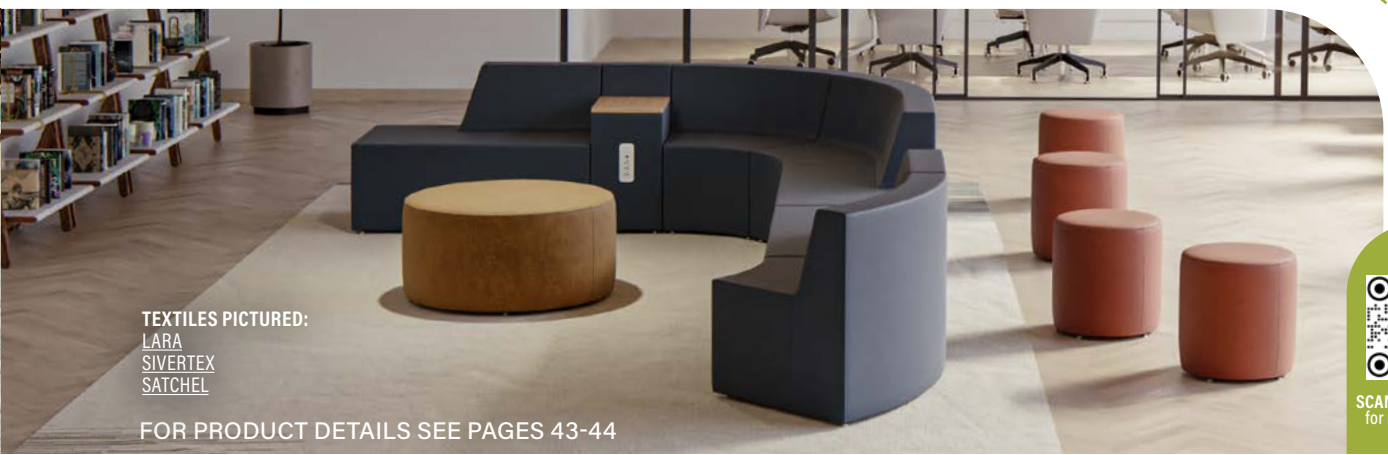

TEXTILES PICTURED:
LARA
SIVERTEX
SATCHEL

FOR PRODUCT DETAILS SEE PAGES 43-44





TEXTILES PICTURED: SIVERTEX

IDEA STARTERS

PRODUCTS: F131, PA131



PRODUCTS: F131



PRODUCTS: F131, PA131



CAFÉ SERIES

Use the Café Series to create community spaces in libraries, informal locations, and of course, dining centers. Energize these spaces with booth installations that help with connection and encourage the development of social and academic relationships essential for success.



CAFÉ BOOTH F131



CAFÉ SEPARATOR PA131



TEXTILES PICTURED: EVO JACKPOT



Clean out profile between the seat and seat-back.



SCAN or CLICK ME for more details

SOCIAL SERIES

Comfortable, functional, and creative are the keystones to the Social Series. Solid foam construction and lightweight design allow for each piece to be arranged easily to suit any environment. Each piece is meticulously designed to meet the demands of form and function.

IDEA STARTERS



PRODUCTS: F150, F151, F152



PRODUCTS: F150, F005-30 (with TFL)



PRODUCTS: F050, F051, F052



PRODUCTS: F050, F051, F052



PRODUCTS: F050, F001 (with TFL), F052, F053, F051



ARMLESS SOCIAL CHAIR F053



CLUB SOCIAL CHAIR F050



RIGHT SOCIAL CHAIR F052



LEFT SOCIAL CHAIR F051



LOW ARM CLUB SOCIAL CHAIR F150



LOW ARM RIGHT SOCIAL CHAIR F152



LOW ARM LEFT SOCIAL CHAIR F151

TEXTILES PICTURED: SIVERTEX



TEXTILES PICTURED: SILICA



SCAN or CLICK ME for more details



NEST SERIES

Our patented Nest Series is where mindfulness and reflection meet. The perfect spot for a little alone time and reflection. The fully zippered and solid foam construction allow for lightweight and easy movement. The Nest Series is a comfortable and safe area to curl up to sit and read or flip on its side to engage with others as a collaborative space.



THE STORY BEHIND THE NEST DESIGN

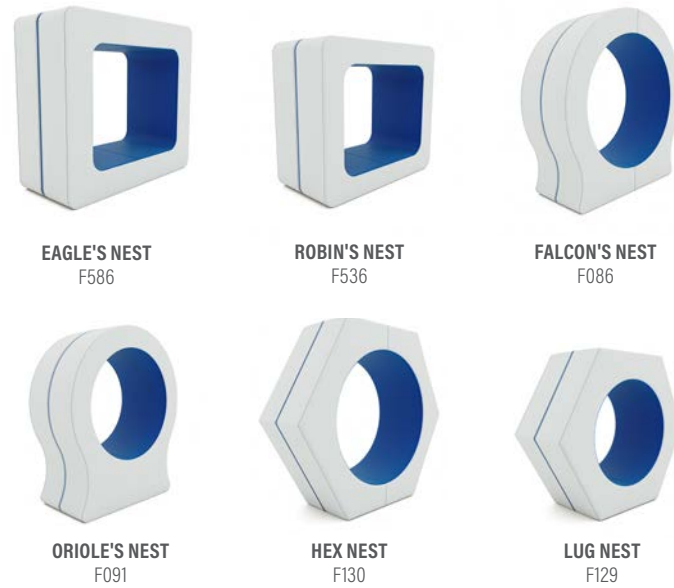

Our patented design!



*Fit multiple Pads inside a Nest
Nest and Pads are sold separately*

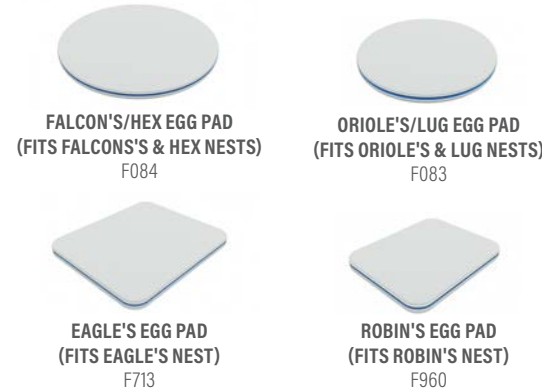

Inspiration can be found in numerous ways and from countless sources. One can find inspiration in a conversation with a friend, a song that pops up on our playlist, or from a walk outside. The students at Desert Hot Springs HS in Desert Hot Springs, California, particularly inspired us. Together with one of our dealer partners, we collaborated with a Career Tech class of Juniors at DHSHS for our first-ever "For Students by Students" project. We had a simple premise: Connect with students and staff at a local school and craft a tailor-made curriculum, allowing students to design a unique piece of furniture that serves a purpose in their classroom. We were amazed by the students' creations! Under the guidance of their Career Tech teacher, Stacy Ward, the students had to come up with "mindful" designs of furniture that would help students relax and realign. For three months, students worked in teams, thinking about the construction and design elements, along with engaging in philosophical conversations about how space affects our emotions, and the purpose furniture should serve in such spaces.

At the end of three months, students presented their ideas and, in the end, landed on the "NEST", a versatile piece that lets students either interact with a group or have a moment of quiet. The students received a NEST for their school, a \$1,000 grant, and they were given the opportunity to learn and discover with a real-world application.



STUDENTS FROM DESERT HOT SPRINGS HIGH SCHOOL



TEXTILES PICTURED: BEGUILLED BY THE WILD SILVERTEX



STEP SERIES

The finely crafted Step Series is built to impress and function in any environment. Solid foam construction means there are no hard edges, and they are light and convenient to move. The perfect solution for creating useful, collaborative seating in even the most unlikely spaces, turning hallways and corridors into collabor-idors! The entire line from the Step Series can be fit together to create countless arrangements.

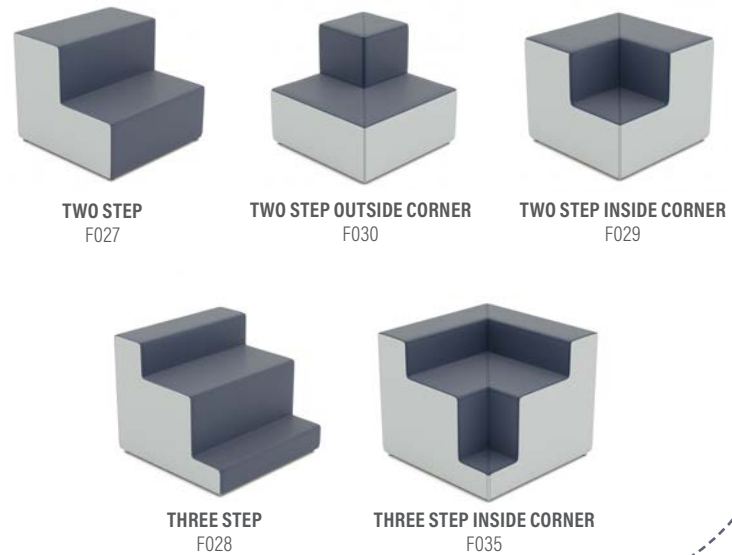

IDEA STARTERS

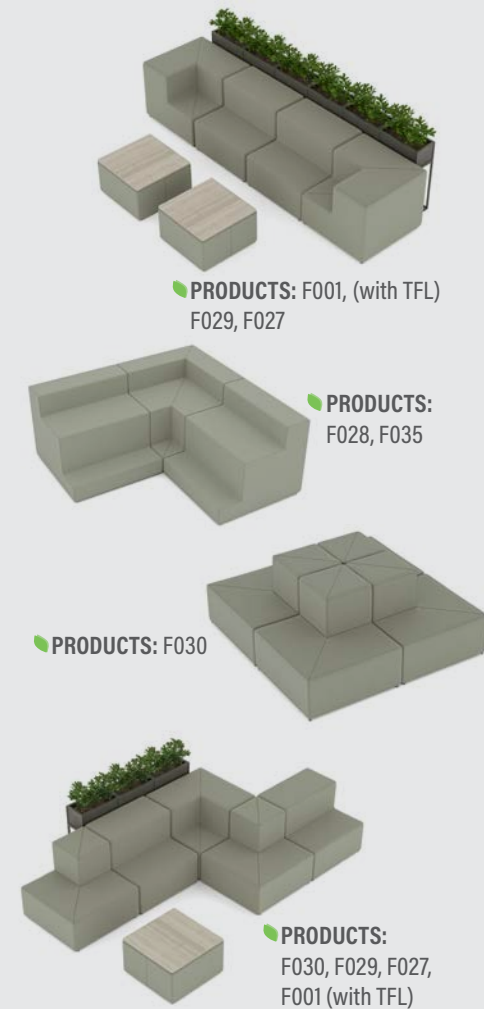

NETWORK SERIES

With our lightweight, solid foam construction, you can maneuver the Network Series into endless combinations. Meetings, gatherings, and even quick chats will flourish in your purposefully curated spaces. Showcasing the variety of geometry from the Network Series, your creativity has no bounds to craft the proper environment for any situation.

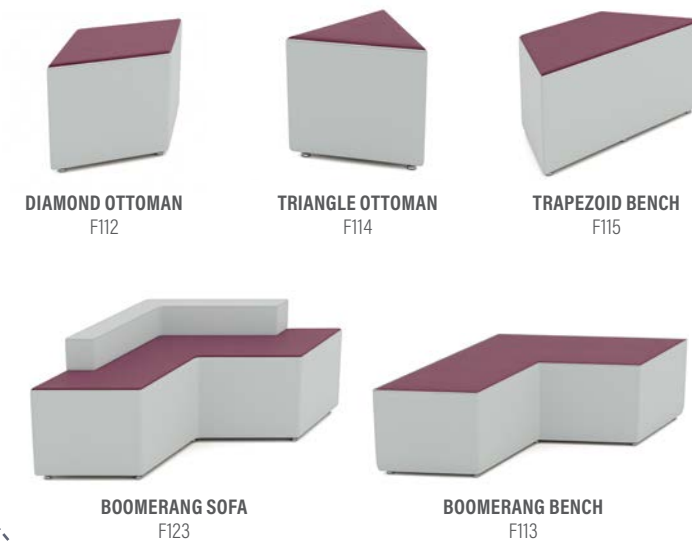

IDEA STARTERS

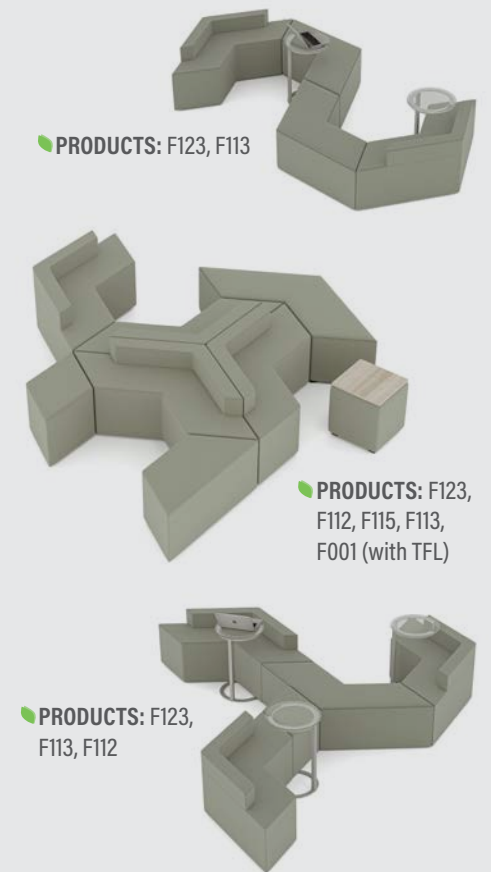

LOTUS SERIES

Change your angle — change your perspective. This fun and functional series is meant to give learners of all ages a comfortable seating option closer to the floor. All of the pieces in the Lotus Series are crafted without a wood base and come fully zippered. Keeping it comfy, whimsical, and giving space for creative energy. Give yourself a new perspective with the Lotus Series.

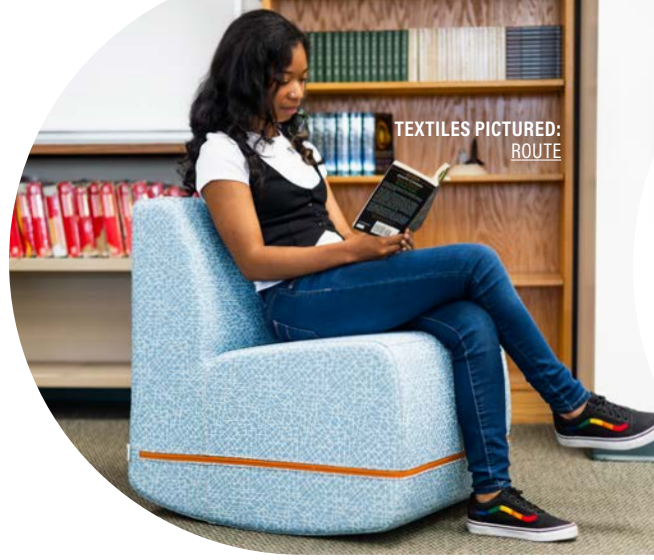

TEXTILES PICTURED:
ROUTE



TEXTILES PICTURED:
SIVERTEX



TEXTILES PICTURED:
SIVERTEX

FOR PRODUCT DETAILS SEE PAGES 50-54

LOTUS SERIES

Many products available in multiple sizes. See pages 50-52 for details.

6" Lily Pads are available.

Pair any Lil Explorers pieces with Lily Pads for even more fun!

Organize your space and make it fun by combining Lily Pads and a Lily Cart.

- ROCK'N ROLLER F165
- ANDERSON CHAIR FK005
- FLOP FK006
- LILY PAD FK007
- LOG OTTOMAN FK501
- HALF DOME FK031
- MEDIA CHAIR F122
- ZERO GRAVITY CHAIR F121
- LILY CART (FITS 10 - 3" LILY PADS) FK007-CART2

SENSORY & SAFE

Hug Chair 2.0 available in Junior and XL sizes

New Design

- HUG CHAIR 2.0 FK034
- HUG CHAIR F721
- FÔM DIVIDER FK028
- FÔM CHAIR FK020
- FÔM DESK FK033



TEXTILES PICTURED:
SIVERTEX



TEXTILES PICTURED:
SIVERTEX

LIL EXPLORERS

Designed to support play-based learning for young children.

Combos available using Lil Explorers pieces. See page 21 for details.

Square available in 3 sizes.

- BRICK FK061
- ARCH FK062
- CURVED RAMP FK063
- STRAIGHT RAMP FK064
- SLAB FK065
- RECTANGLE FK066
- STEP FK067
- SQUARE FK068
- L-STEP FK069
- CYLINDER FK070

New Design

- BUBBA BELUGA F170
- DUNCAN DUCK F171
- ROXY T-REX F172
- BO BRACHO F173
- TURBO TRIKE F174
- HUGO HORSE F175

ROCK'N IN THE WILD

TEXTILES PICTURED:
SIVERTEX



SCAN or CLICK ME for more details



TEXTILES PICTURED:
BAYSIDE



TEXTILES PICTURED:
BAYSIDE

WEATHER RESISTANT SERIES

TEXTILES PICTURED:
BAYSIDE

MARINE GRADE
NYLON THREAD

SOLID FOAM
CONSTRUCTION

VINYL WITH UV &
FADE RESISTANT
PROTECTION
(AVAILABLE IN 28 COLORS!)

MADE IN THE USA

QUICK DRY
OUTDOOR FOAM

EXTERIOR
WOOD BASE

LOW PROFILE LEGS
*INCREASES SCRATCH
RESISTANCE*

New **WEATHER RESISTANT
SERIES**

Soft, durable, quick drying, lightweight, and weather resistant is what you can expect from Fōmcore's new outdoor-friendly furniture. Produced using marine grade nylon thread and Bayside vinyl with UV and fade resistant protection, you can enjoy the same Fōmcore quality and craftsmanship backed with a 3-year warranty.*



1" LOW PROFILE
BLACK LEG (L1)



RECTANGLE OTTOMAN
FW001



CRESCENT OTTOMAN
FW003



HONEYCOMB OTTOMAN
FW004



SPIN WEDGE OTTOMAN
FW055



PETAL OTTOMAN
FW101



18" ROUND OTTOMAN
FW005-18



30" ROUND OTTOMAN
FW005-30



36" ROUND OTTOMAN
FW005-36



BENCH 48
FW009

**See page 65 for 3-year warranty details.*



**EASILY TRANSITION FURNITURE
FROM INDOOR TO OUTDOOR.**

TEXTILES PICTURED:
BAYSIDE



SCAN or CLICK ME
for more details

CREATE YOUR COMBO

Add fun and creative group learning areas to any room by creating your own combo! Place one of these combos in a room and watch learners of all ages naturally migrate towards the comfortable and inviting seating. Combos are also a mindful solution for breakout spaces.

See product availability for adult & junior sizes on pages 57-60.

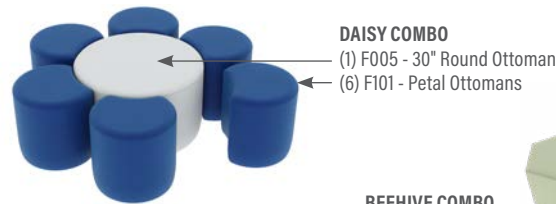

DAISY COMBO
(1) F005 - 30" Round Ottoman
(6) F101 - Petal Ottomans



BEEHIVE COMBO
(7) F004 - Honeycomb Ottomans



SPIN COMBO
(5) F055 - Spin Wedge Ottomans
(6) F055 - Spin Wedge Ottomans

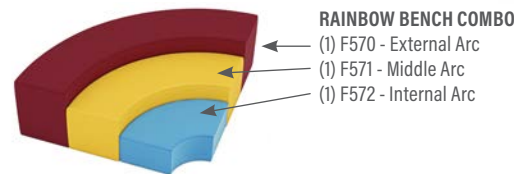

RAINBOW BENCH COMBO
(1) F570 - External Arc
(1) F571 - Middle Arc
(1) F572 - Internal Arc

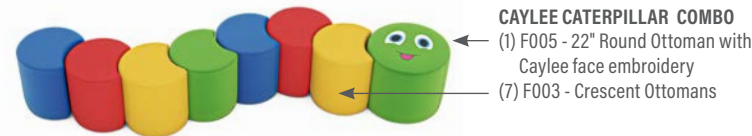

CAYLEE CATERPILLAR COMBO
(1) F005 - 22" Round Ottoman with Caylee face embroidery
(7) F003 - Crescent Ottomans

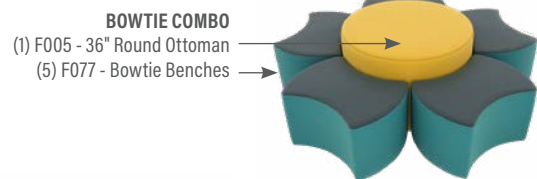

BOWTIE COMBO
(1) F005 - 36" Round Ottoman
(5) F077 - Bowtie Benches

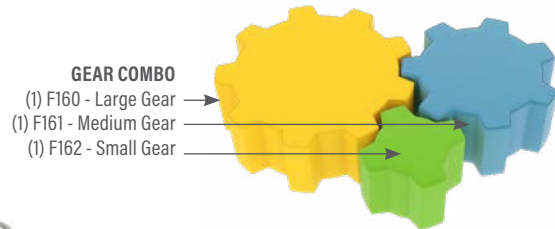

GEAR COMBO
(1) F160 - Large Gear
(1) F161 - Medium Gear
(1) F162 - Small Gear

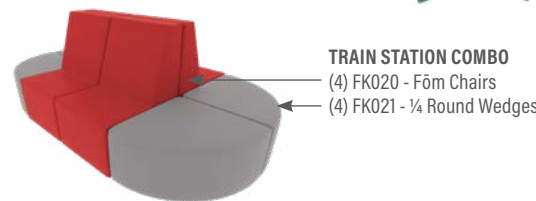

TRAIN STATION COMBO
(4) FK020 - Fom Chairs
(4) FK021 - 1/4 Round Wedges



CONVO LILY PAD AND CART COMBO
(10) FK007 - 3" Lily Pads
(1) FK007-CART2 - Lily Cart



BALANCE BEAM COMBO
(2) FK042 - Balance Beam Corners
(3) FK041 - Balance Beams

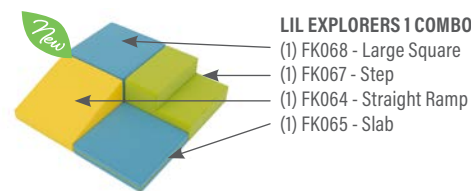

LIL EXPLORERS 1 COMBO
(1) FK068 - Large Square
(1) FK067 - Step
(1) FK064 - Straight Ramp
(1) FK065 - Slab

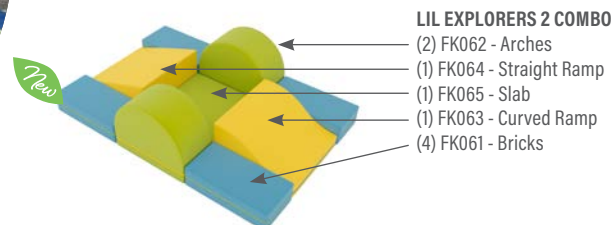

LIL EXPLORERS 2 COMBO
(2) FK062 - Arches
(1) FK064 - Straight Ramp
(1) FK065 - Slab
(1) FK063 - Curved Ramp
(4) FK061 - Bricks



TEXTILES PICTURED:
SIVERTEX



TEXTILES PICTURED:
SIVERTEX
BANDWIDTH

CREATE YOUR COMBO

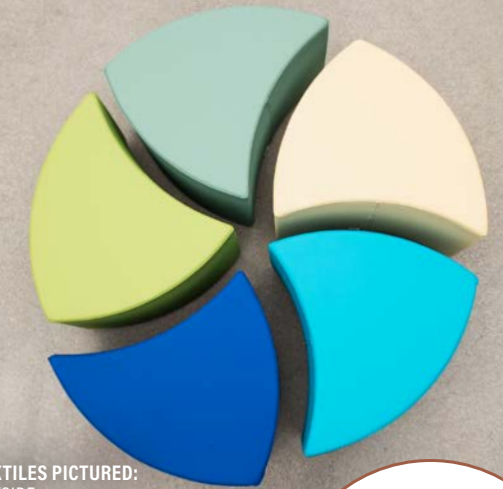

TEXTILES PICTURED:
BAYSIDE

CAMPFIRE COMBO

EDUCATIONAL STORY

The new Campfire Combo is a perfect arrangement for students to gather for group time and shared learning. By design, the Campfire Combo draws students in; gathering them around a shared "Foam Flame" focal point. With 3 different colors of foam triangles, the Foam Flame serves as an interactive instructional tool for facilitating a group. Teachers can quickly split students up to gather around one of the 3 flames for group break outs (ex: "Red Flames, let's gather on this side of the campfire; Yellow Flames, over on the other side").

Other possibilities include the flexibility it gives teachers in providing directives based on what color flame a student is holding (ex: "When the Orange Flame is passed to you, share a time something made you laugh. When you receive the Yellow Flame, turn to the person next to you and give them a compliment"). Further, the Log Ottomans are constructed of solid foam making them lightweight and durable, perfect for students to rearrange yet strong enough for the demands of the classroom.

Log Ottomans are displaying our custom Tree Bark & Rings textile.

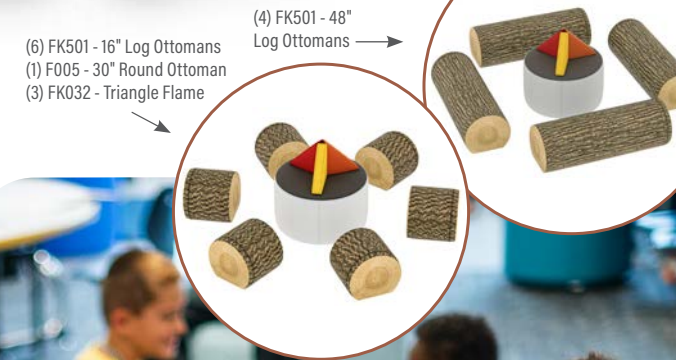

(4) FK501 - 48" Log Ottomans
(1) F005 - 30" Round Ottoman
(3) FK032 - Triangle Flame



TEXTILES PICTURED:
SIVERTEX
TREE BARK AND RINGS



SCAN or CLICK ME
for more details

FÔM FILLED SERIES

Our Fôm Bean Bags and Loungers are meant to replace the traditional bean bags. Not only are they easy to clean and comfortable, they are what bean bag style chairs should be. Sturdy yet flexible and comfy for hours on end. Each one is made by a master craftsman and built to last.



FÔM BEAN BAG
FF003 (3' BAG)
FF004 (4' BAG)



FÔM LOUNGER
FF017 (5' LOUNGER)
FF012 (6' LOUNGER)
FF013 (7' LOUNGER)



TEXTILES PICTURED:
MIRCOSUEDE

5' FÔM LOUNGER



TEXTILES PICTURED:
MIRCOSUEDE

7' FÔM LOUNGER



3' FÔM BEAN BAG

TEXTILES PICTURED:
MIRCOSUEDE



TEXTILES PICTURED:
MIRCOSUEDE

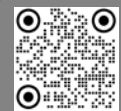

SCAN or CLICK ME for more details

FOR PRODUCT DETAILS SEE PAGE 61

FÔM FILLED MIRCOSUEDE

- | | | | |
|--|---|--|---|
| 
MIRCOSUEDE NAVY-112 | 
MIRCOSUEDE RED-113 | 
MIRCOSUEDE PURPLE-114 | 
MIRCOSUEDE LIGHT GREEN-115 |
| 
MIRCOSUEDE LIGHT BLUE-116 | 
MIRCOSUEDE BLACK-117 | 
MIRCOSUEDE BROWN-118 | 
MIRCOSUEDE DARK GREY-119 |



SILVERTEX NEO

GRADE ONE - VINYL













BY SPRADLING | VINYL, PERMABLOK TOPCOAT | ABRASION 100,000

- | | | | | | | | | |
|--|--|--|--|--|--|--|---|--|
| 
SILVERTEX NEO MARINE BLUE | 
SILVERTEX NEO LAGOON | 
SILVERTEX NEO TURQUOISE | 
SILVERTEX NEO PLATA | 
SILVERTEX NEO STORM | 
SILVERTEX NEO SAPPHIRE | 
SILVERTEX NEO JET | 
SILVERTEX NEO STERLING | 
SILVERTEX NEO NEUTRA |
| 
SILVERTEX NEO METEOR | 
SILVERTEX NEO CARBON | 
SILVERTEX NEO CREME DE MENTHE | 
SILVERTEX NEO ACID | 
SILVERTEX NEO BASIL | 
SILVERTEX NEO BOTTLE | 
SILVERTEX NEO LIMONCELLO | 
SILVERTEX NEO ZEST | 
SILVERTEX NEO CELERY |
| 
SILVERTEX NEO SAGE | 
SILVERTEX NEO BAZAAR | 
SILVERTEX NEO CHAMPAGNE | 
SILVERTEX NEO MARSH | 
SILVERTEX NEO PEAT | 
SILVERTEX NEO MANDARIN | 
SILVERTEX NEO CHESTNUT | 
SILVERTEX NEO BRONZE | 
SILVERTEX NEO TAUPE |
| 
SILVERTEX NEO IMPERIAL | 
SILVERTEX NEO POPPY | 
SILVERTEX NEO UMBER | 
SILVERTEX NEO LUGGAGE | 
SILVERTEX NEO MOCHA | 
SILVERTEX NEO BORSCHT | 
SILVERTEX NEO RASPBERRY | 
SILVERTEX NEO BLACKBERRY | 
SILVERTEX NEO CREAM |
| 
SILVERTEX NEO ICE | 
SILVERTEX NEO BLACK | | | | | | | |

LINETTE

GRADE ONE - VINYL

BY CULP | VINYL | ABRASION 100,000

- | | | | | | | | | |
|--|--|---|--|--|---|---|--|---|
| 
LINETTE ASH | 
LINETTE BLACK | 
LINETTE COLA | 
LINETTE DENIM | 
LINETTE FLAME | 
LINETTE FROST | 
LINETTE GLACIER | 
LINETTE GLAZE | 
LINETTE MOSS |
| 
LINETTE MUSTARD | 
LINETTE PEACOCK | 
LINETTE PLATINUM | 
LINETTE STEEL | 
LINETTE STONE | 
LINETTE TOFFEE | 
LINETTE WATERSCAPE | | |

CHAMBRAY NEO

GRADE ONE - PRINTED VINYL

BY SPRADLING | VINYL | ABRASION 100,000

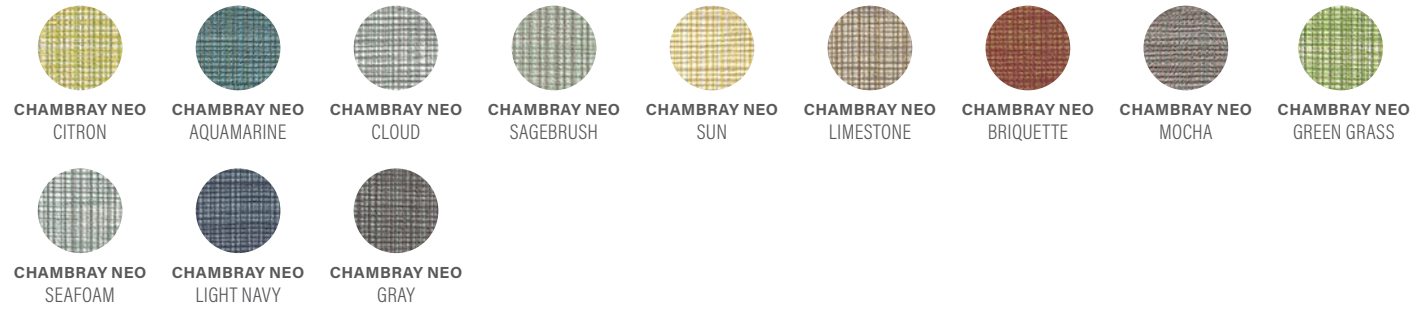

MILANO STITCH

GRADE ONE - PRINTED VINYL

BY SPRADLING | VINYL | ABRASION 100,000



DILLON

GRADE ONE - POLYURETHANE

BY CULP | POLYURETHANE | ABRASION 200,000



VARSITY

GRADE ONE - VINYL

BY MORBERN | VINYL | ABRASION 100,000

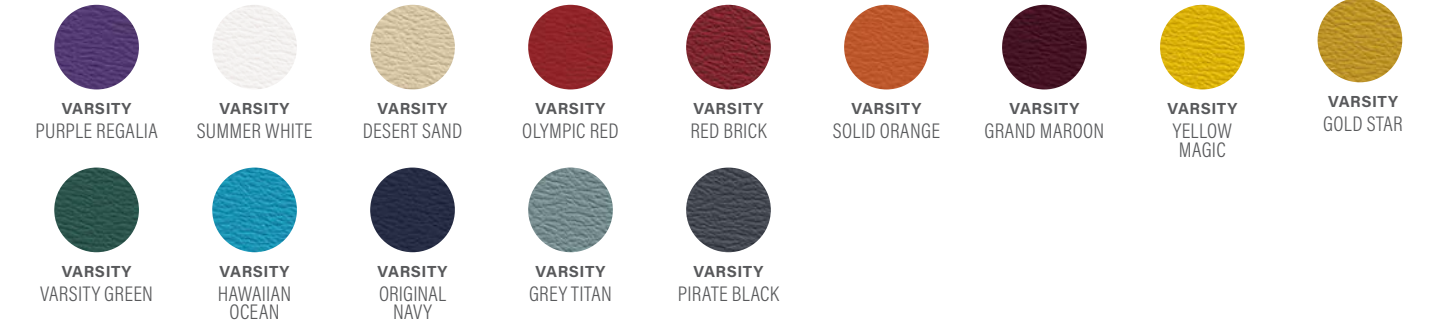

BAYSIDE

GRADE ONE - VINYL

BY MORBERN | VINYL | ABRASION 250,000



BAYSIDE IS AVAILABLE ON WEATHER RESISTANT AND NON-WEATHER RESISTANT PRODUCTS

SEE ALL TEXTILE GRADES

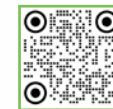

SCAN or CLICK ME

SILICA CUSP PIER GRADE SEVEN

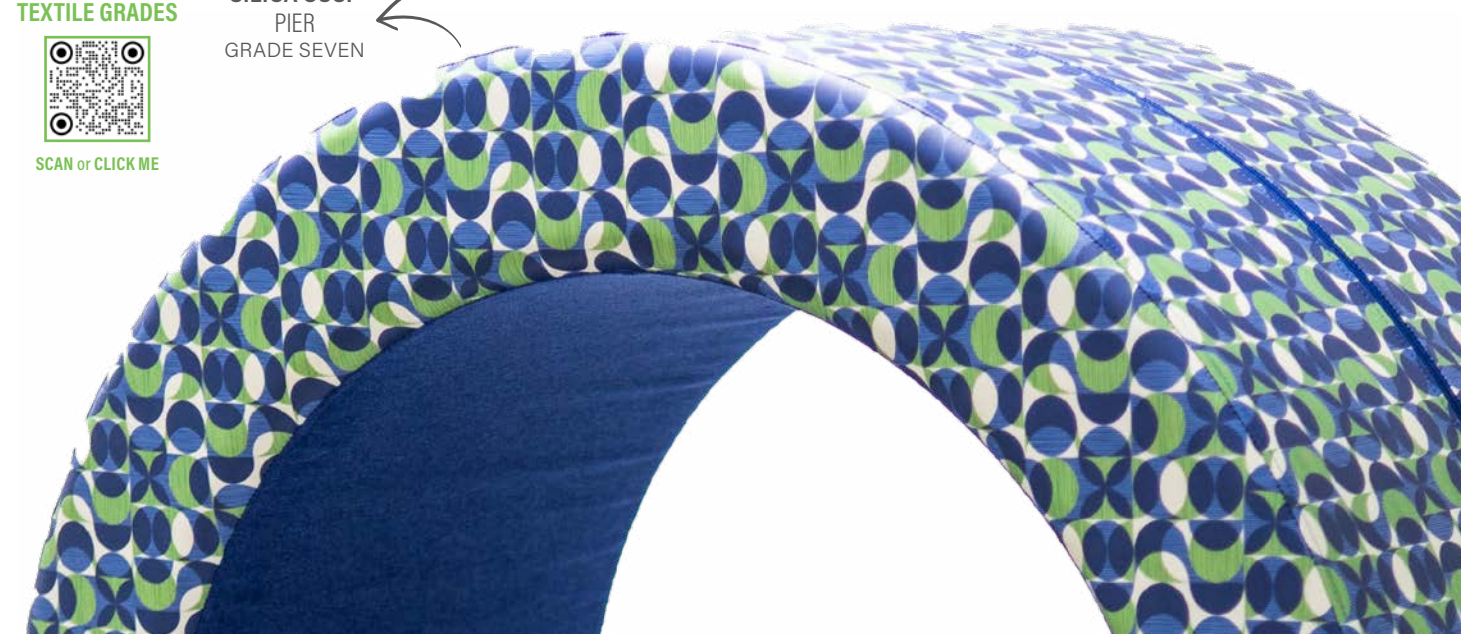

MAKE IT YOUR OWN MODIFICATIONS

1" STANDARD LEG OPTIONS



1" NYLON
GLIDE (G1)



1" FELT
GLIDE (G1)



1" LOW
PROFILE (L1)

3" PREMIUM LEGS & CASTERS



3" RECTANGLE
LEG (R3)



3" CASTER (C3)

6" PREMIUM LEGS & CASTERS



6" CASTER (C6)



6" MOD LEG (M6)



6" RECTANGLE
LEG (R6)



6" TRIANGLE
LEG (T6)



6" SLED LEG
(S16, S29)



PRODUCTS PICTURED:
LINEAR REFRESH CHAIR

TEXTILES PICTURED:
VARSITY
LINETTE

TFL WORK SURFACE

Top it off! With one of our 6 Thermally Fused Laminate (TFL) work surface options. Add a table top surface to our standard pieces like the Round and Rectangle Ottomans.



MARKER BOARD



NATURAL MAPLE



WHITE WOOD



DARK WOOD



BLACK CRYSTAL



FASHION GREY



PRODUCTS PICTURED:
RECTANGLE OTTOMAN
TEXTILES PICTURED:
SILVERTEX
VARSITY
LINETTE

POWER UP!

Many of our products have the ability to be POWERED UP! Our new embedded power units are a versatile and sleek option when multiple power options are needed in a space. View the Power Reference Guide on pages 63-64 for power placement locations.

- USB/AC combination
- 10' cable length
- For 2 or more power units contact your regional sales director

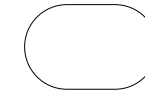

WHITE

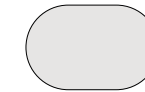

SILVER



PRODUCTS PICTURED:
CONNECT LOW BACK TABLE
TEXTILES PICTURED:
LINETTE

EMBROIDERY

We have the ability to embroider artwork up to 12" x 15" on any item we offer. Let our trained professionals help you showcase your school or company pride; all we need is the high resolution artwork.



TEXTILES PICTURED:
VARSITY
LINETTE



DESIGN SERVICES

HOW CAN WE HELP YOU?

We have the tools, experience, and relationships to help you with your next project no matter how big or small. Our team of designers and engineers are prepared to handle whatever you are dreaming of for your space. Although we are the foam experts specializing in soft-seating, we have partnered with our friends at WB Manufacturing to bring a full range of case-work and hard surfaces to round out your entire space planning experience and meet all of your needs!

YOUR DESIGN RESOURCES:

IN-HOUSE DESIGN SERVICES
 Space Planning
 Technical Design
 Renderings

CUSTOM PRODUCTS
 Concept Design
 Imagery
 Product Testing

DESIGN SYMBOLS
 2D/3D CAD
 Kits Collaborator
 Project Matrix
 Revit
 CET

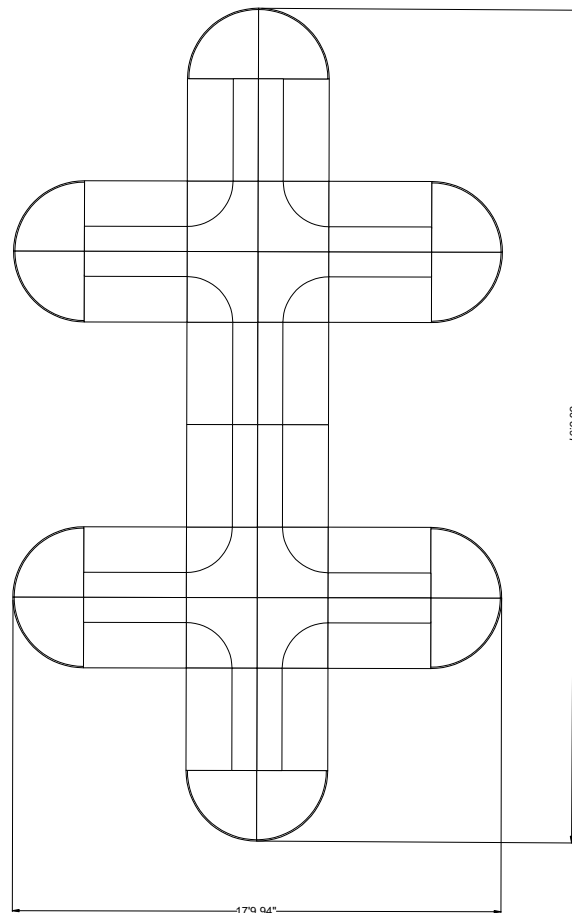

PRODUCTS PICTURED:
 ARMLESS CURVED CORNER
 LINEAR ARMLESS LOVESEAT
 LINEAR WEDGE

TEXTILES PICTURED:
 VARSITY
 LINETTE



AT A GLANCE



PRODUCTS PICTURED:
ANDERSON CHAIR
LINEAR LOVESEAT
ARMLESS CURVED CORNER

TEXTILES PICTURED:
VARSITY
LINETTE
BIG DOT



PRODUCTS PICTURED:
LOW ARM CLUB SOCIAL CHAIR

TEXTILES PICTURED:
SILVERTEX



PRODUCTS PICTURED:
HONEYCOMB OTTOMAN

TEXTILES PICTURED:
LINETTE



PRODUCTS PICTURED:
LIL EXPLORERS COMBO 2

TEXTILES PICTURED:
SILVERTEX



PRODUCTS PICTURED:
CONNECT LOW BACK TABLE
CONNECT LOW BACK CURVED CHAIR

TEXTILES PICTURED:
LINETTE



PRODUCTS PICTURED:
HEX NEST

TEXTILES PICTURED:
BEGUILLED BY THE WILD
SILVERTEX



PRODUCTS PICTURED:
CAMPFIRE COMBO

TEXTILES PICTURED:
SILVERTEX
TREE BARK AND RINGS



PRODUCTS PICTURED:
RECTANGLE OTTOMAN
(WITH TFL)
LINEAR REFRESH SOFA

TEXTILES PICTURED:
VARSITY
LINETTE
SILVERTEX



PRODUCTS PICTURED:
THREE STEP

TEXTILES PICTURED:
MIXOLOGY
EVO



PRODUCTS PICTURED:
GEAR COMBO

TEXTILES PICTURED:
SILVERTEX

WHY FOAM?

SEE THE DIFFERENCE.

NOT-SO "SOFT SEATING"



FŌMCORE

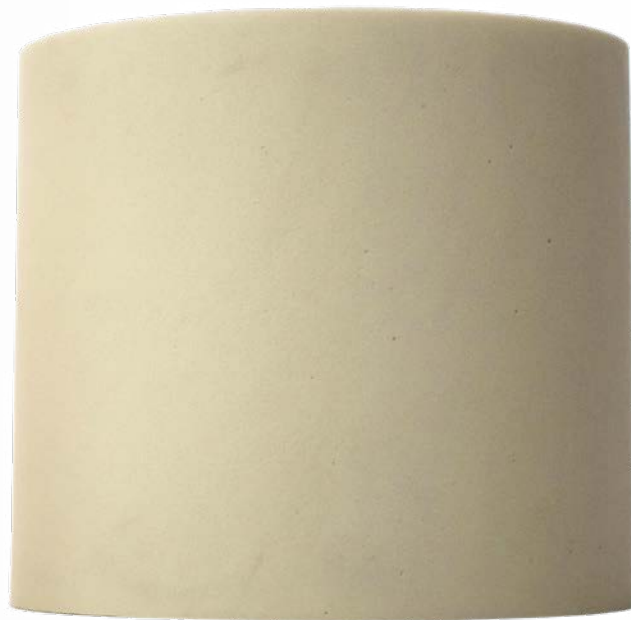

LIFETIME WARRANTY

Our craftsmanship and attention to detail is what allows us to offer a lifetime warranty.* While other products deteriorate over time due to poor structure, our high-quality foam guarantees your Fōmcore products will withstand the test of time.



QUALITY FOAM AND DENSITY

When thin, cheap foam is wrapped around a wood base, it will deteriorate quickly causing puddling. We use the highest quality, 35#, 70#, and 100# foam possible and have formulated our own proprietary formula for maximum durability.



SOLID FOAM vs. WOOD FRAME

While most of our competitors use a wood frame covered by thin layers of foam, our use of solid foam allows for better durability and flexibility. Adapt the space in any environment with ease while at the same time knowing it won't lose its shape over the years.



NO PINCH POINTS

There's no need to worry about squishing any fingers or toes with any of our fully zippered pieces, making our active seating a fun and safe choice.



CUSTOM SHAPES

Because we use solid foam construction, we are able to create and cut an endless variety of custom shapes on our foam saws. From dolphins to dog bones, our team is ready to bring any idea to life.



LIGHT vs. HEAVY

Our lightweight foam construction allows for adaptability in a variety of environments. Other not-so soft seating can be heavy and bulky and difficult to re-arrange quickly and efficiently.



SOFT EDGE vs. HARD EDGE

When fabric is stretched around a thin layer of foam and wood frame, you can feel it! With solid foam construction you will never feel a hard edge no matter how hard you push into the top of the furniture, making it a safe option for virtually any environment.



WATCH A VIDEO ABOUT HOW OUR FOAM COMPARES WITH THE COMPETITION.



SCAN or CLICK ME

*See page 65 for lifetime warranty details.

PET PANEL - CAFÉ SEPARATOR (PA131)

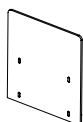

Panel attaches to the back of the Café Booth and is only available in Heather Grey

Table with columns for Product No., Dimen./Weight, Foot Options (Zip, Standard, 3" Premium, 6" Premium), Integrated Power Options (Standard, 3" Premium, 6" Premium), TFL, and Emb. for product PA131.

Social Series

DETAILS

CONSTRUCTION:

- Solid foam construction
Reinforced seams and stitching
Wood baseboard to fit foot options
Made in USA
Backed with a lifetime warranty
*See page 65

MODIFICATION:

- Textile and placement
Leg, caster, and foot options
Stitching color
TFL work surface
Power options
Embroidery

CLUB SOCIAL CHAIR (F050)

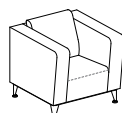

Table with columns for Product No., Dimen./Weight, Foot Options, Integrated Power Options, TFL, and Emb. for product F050-35x36x32.

LEFT SOCIAL CHAIR (F051)



Table with columns for Product No., Dimen./Weight, Foot Options, Integrated Power Options, TFL, and Emb. for product F051-28.25x36x32.

RIGHT SOCIAL CHAIR (F052)



Table with columns for Product No., Dimen./Weight, Foot Options, Integrated Power Options, TFL, and Emb. for product F052-28.25x36x32.

LOW ARM CLUB SOCIAL CHAIR (F150)



Table with columns for Product No., Dimen./Weight, Foot Options, Integrated Power Options, TFL, and Emb. for product F150-35x34.75x32.

LOW ARM LEFT SOCIAL CHAIR (F151)



Table with columns for Product No., Dimen./Weight, Foot Options, Integrated Power Options, TFL, and Emb. for product F151-28.25x34.75x32.

LOW ARM RIGHT SOCIAL CHAIR (F152)



Table with columns for Product No., Dimen./Weight, Foot Options, Integrated Power Options, TFL, and Emb. for product F152-28.25x34.75x32.

ARMLESS SOCIAL CHAIR (F053)



Table with columns for Product No., Dimen./Weight, Foot Options, Integrated Power Options, TFL, and Emb. for product F053-21.5x36x32.

Nest Series

DETAILS

CONSTRUCTION:

- Solid foam construction
Reinforced seams and stitching
Fully zippered (no wood base)
Patented design
Made in USA
Backed with a lifetime warranty
*See page 65

MODIFICATION:

- Textile and placement
Stitching and zipper colors
Embroidery

ROBIN'S NEST (F536)

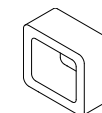
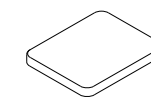

Table with columns for Product No., Dimen./Weight, Foot Options, Integrated Power Options, TFL, and Emb. for product F536-45x21.25x39.

ROBIN'S EGG PAD (F960)



6 pads fit into the Robin's Nest

Table with columns for Product No., Dimen./Weight, Foot Options, Integrated Power Options, TFL, and Emb. for product F960-33x27x3.

EAGLE'S NEST (F586)

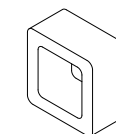
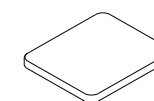

Table with columns for Product No., Dimen./Weight, Foot Options, Integrated Power Options, TFL, and Emb. for product F586-57x24x51.

EAGLE'S EGG PAD (F713)



7 pads fit into the Eagle's Nest

Table with columns for Product No., Dimen./Weight, Foot Options, Integrated Power Options, TFL, and Emb. for product F713-40x34.5x3.

DETAILS

CONSTRUCTION:

- Reinforced seams and stitching
- Fully zippered
- Machine washable cover
- Microsuede textile
- Made in USA
- Backed with a lifetime warranty
- *See page 65

MODIFICATION:

- Microsuede textile color

3' FÕM BEAN BAG (FF003)

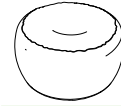

Product No.	Dimen./Weight (L x W x H)	FOOT OPTIONS						INTEGRATED POWER OPTIONS												TFL	Emb.				
		Zip Z	Standard		3" Premium		6" Premium		Standard		3" Premium		6" Premium		6" Premium										
			G1	L1	R3	C3	S16	S29	C6	T6	R6	M6	G1	L1	R3	C3	S16	S29	C6	T6	R6	M6			
FF003	36" x 36" x 24" 20 lbs.	✓	-	-	-	-	-	-	-	-	-	-	-	-	-	-	-	-	-	-	-	-	-	-	-

4' FÕM BEAN BAG (FF004)



Product No.	Dimen./Weight (L x W x H)	FOOT OPTIONS						INTEGRATED POWER OPTIONS												TFL	Emb.				
		Zip Z	Standard		3" Premium		6" Premium		Standard		3" Premium		6" Premium		6" Premium										
			G1	L1	R3	C3	S16	S29	C6	T6	R6	M6	G1	L1	R3	C3	S16	S29	C6	T6	R6	M6			
FF004	48" x 48" x 31" 45 lbs.	✓	-	-	-	-	-	-	-	-	-	-	-	-	-	-	-	-	-	-	-	-	-	-	-

5' FÕM LOUNGER (FF017)



Product No.	Dimen./Weight (L x W x H)	FOOT OPTIONS						INTEGRATED POWER OPTIONS												TFL	Emb.				
		Zip Z	Standard		3" Premium		6" Premium		Standard		3" Premium		6" Premium		6" Premium										
			G1	L1	R3	C3	S16	S29	C6	T6	R6	M6	G1	L1	R3	C3	S16	S29	C6	T6	R6	M6			
FF017	60" x 48" x 48" 60 lbs.	✓	-	-	-	-	-	-	-	-	-	-	-	-	-	-	-	-	-	-	-	-	-	-	-

6' FÕM LOUNGER (FF012)



Product No.	Dimen./Weight (L x W x H)	FOOT OPTIONS						INTEGRATED POWER OPTIONS												TFL	Emb.				
		Zip Z	Standard		3" Premium		6" Premium		Standard		3" Premium		6" Premium		6" Premium										
			G1	L1	R3	C3	S16	S29	C6	T6	R6	M6	G1	L1	R3	C3	S16	S29	C6	T6	R6	M6			
FF012	72" x 48" x 48" 70 lbs.	✓	-	-	-	-	-	-	-	-	-	-	-	-	-	-	-	-	-	-	-	-	-	-	-

7' FÕM LOUNGER (FF013)

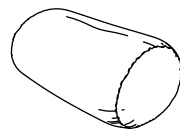

Product No.	Dimen./Weight (L x W x H)	FOOT OPTIONS						INTEGRATED POWER OPTIONS												TFL	Emb.				
		Zip Z	Standard		3" Premium		6" Premium		Standard		3" Premium		6" Premium		6" Premium										
			G1	L1	R3	C3	S16	S29	C6	T6	R6	M6	G1	L1	R3	C3	S16	S29	C6	T6	R6	M6			
FF013	84" x 48" x 48" 85 lbs.	✓	-	-	-	-	-	-	-	-	-	-	-	-	-	-	-	-	-	-	-	-	-	-	-



PRODUCTS PICTURED:
LIL EXPLORERS PIECES
TEXTILES PICTURED:
SILVERTEX



PRODUCTS PICTURED:
HEX NEST
ANDERSON CHAIR
TEXTILES PICTURED:
SILVERTEX
LINETTE
BIG DOT



PRODUCTS PICTURED:
MEDIA CHAIR
TEXTILES PICTURED:
BOBBY
SILVERTEX



PRODUCTS PICTURED:
LILY PAD
TEXTILES PICTURED:
CONVO DOODLE



PRODUCTS PICTURED:
XL TRAIN STATION
TEXTILES PICTURED:
BANDWIDTH
SILVERTEX



PRODUCTS PICTURED:
ROCK'N ROLLER
TEXTILES PICTURED:
ROUTE



PRODUCTS PICTURED:
DUNCAN DUCK
BO BRACO
TEXTILES PICTURED:
SILVERTEX



PRODUCTS PICTURED:
LINEAR REFRESH CHAIR
TEXTILES PICTURED:
SILICA CUSP
SILICA

Product Name	Standard Power Location
F001-18x18 Rectangle Ottoman	
F001-31x31 Rectangle Ottoman	
F005-30 Round Ottoman	
F005-36 Round Ottoman	
F009 Bench 48	
F015 Arc Bench 60	
F016 Linear Chair	
F017 Linear Loveseat	
F019 Linear Sofa	

Product Name	Standard Power Location
F139 Linear Refresh Chair	
F140 Linear Refresh Loveseat	
F141 Linear Refresh Sofa	
F133 Connect Low Back Sofa	
F135 Connect Low Back Chair	
F138 Connect Low Back Table	
F150 Low Arm Club Social Chair	
F151 Low Arm Left Social Chair	
F152 Low Arm Right Social Chair	

Product Name	Standard Power Location
F050 Club Social Chair	
F051 Left Social Chair	
F052 Right Social Chair	
F053 Armless Social Chair	
F027 Two Step	
F029 Two Step Inside Corner	
F030 Two Step Outside Corner	
F028 Three Step	
F035 Three Step Inside Corner	

Product Name	Standard Power Location
F113 Boomerang Bench	
F123 Boomerang Sofa	
F115 Trapezoid Bench	



TEXTILES PICTURED: XXXXXXX



CUSTOMER SERVICE

INFORMATION & MORE

PURCHASE ORDERS

Be sure to include:

1. Quantity
2. SKU Number
3. Description
4. Pattern name and color choice
5. Color guide for items requiring one
6. Price for each item

Fōmcore accepts orders via:

- Email: sales@fomcore.com
- Contact your regional sales director

Modification of orders must be submitted to Fōmcore in writing within 48 hours of initial sales order acknowledgment. In some cases, a change order fee may be charged if work is in progress or custom products are involved.

TERMS

Invoice terms for credit accounts are Net 30 days. Orders are invoiced on day of shipment. New customers and international customers are cash in advance.

SHIPPING - LEAD TIMES

All furniture is made to order. Shipping date is confirmed upon receipt of order. Every attempt will be made to meet that shipping date, however, it is subject to change without prior notification. Fōmcore reserves the right to discontinue products and change product specifications and prices. Fōmcore delivers to all 48 contiguous states. All orders delivering to other states and international locations are FOB Muskegon (zip code 49442), Michigan.

WARRANTY

Product manufactured by Fōmcore is warranted to be free of defects in material and workmanship under normal use for the lifetime of the product, unless otherwise noted.* Product must be properly cared for, maintained, and in use by its original owner. This warranty is non-transferrable, and damage/defects that occur in transit or by acts of negligence, abuse, abnormal usage, misuse, accidents, or alterations nullify the warranty. Conditions resulting from the normal aging and wear of textile(s), filling material(s), and finish(es) are excluded from this warranty. As Buyer's sole remedy under this warranty, Fōmcore, at its option, will credit, repair, or replace damaged product at no charge to the original owner of record provided the replacement or return has previously been authorized by Fōmcore under terms of this warranty. It is expressly agreed that this remedy of repair, replacement, or credit, at Fōmcore's option, is Buyer's exclusive remedy under this warranty. This warranty is non-transferrable. In no event shall Fōmcore be liable for consequential damages.

*Weather resistant product is warranted for three (3) years from the date of product shipment.

GET IN TOUCH WITH OUR REGIONAL DIRECTORS



Dave Diller
REGIONAL DIRECTOR - WEST
PHONE: 231.366.4791 x319
DIRECT: 231.246.1536
EMAIL: dave@fomcore.com



Mark Gardner
REGIONAL DIRECTOR - MIDWEST/CANADA
PHONE: 231.366.4791 x321
DIRECT: 231.246.4564
EMAIL: mark@fomcore.com

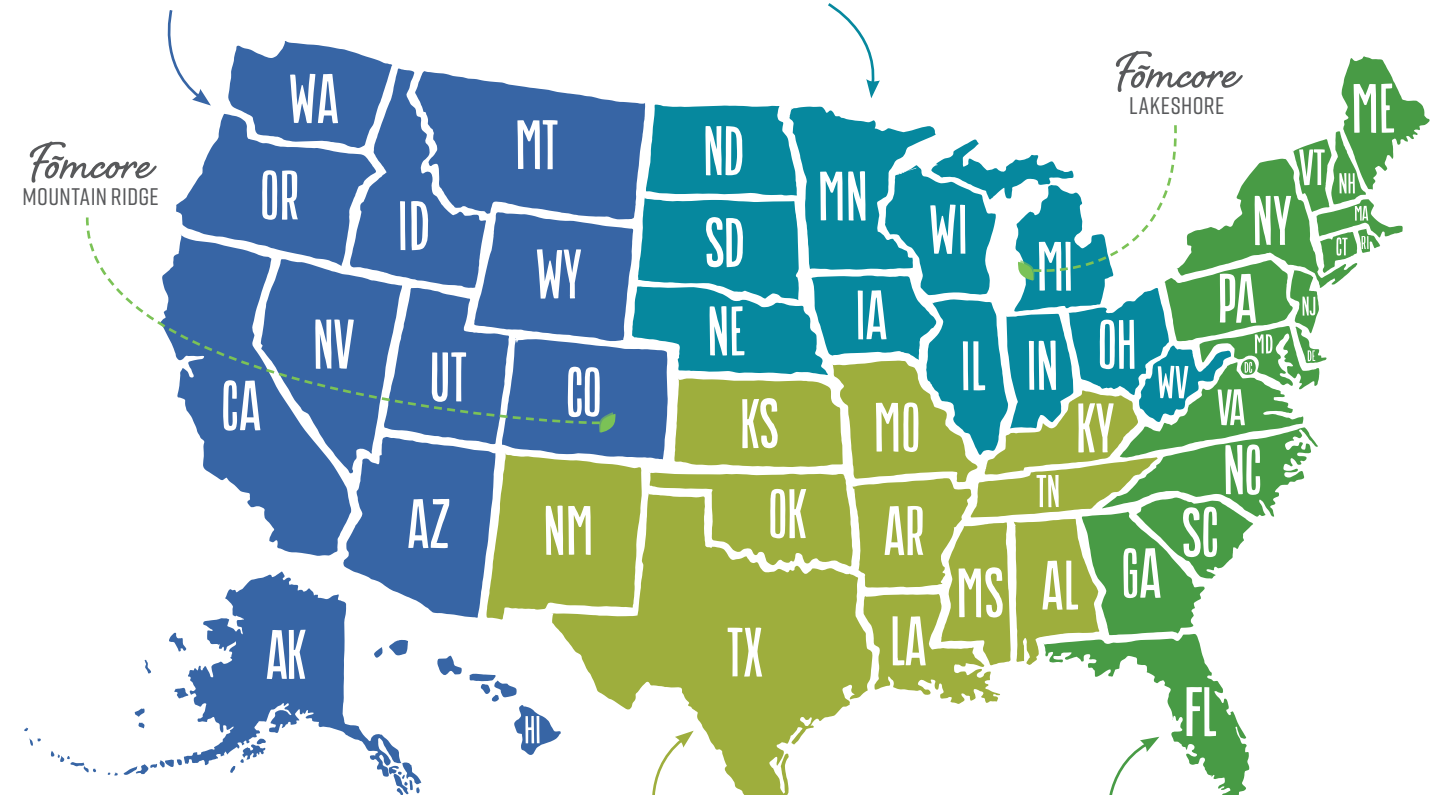

Fōmcore
1770 E. Keating Ave Muskegon, MI 49442
Tel: 231.366.4791 • www.fomcore.com



Lance Wild
REGIONAL DIRECTOR - SOUTH
PHONE: 231.366.4791 x320
DIRECT: 231.246.4563
EMAIL: lance@fomcore.com



Caleb Gibert
REGIONAL DIRECTOR - EAST
PHONE: 231.366.4791 x322
DIRECT: 231.246.4566
EMAIL: caleb@fomcore.com

OUR COMMITMENT TO THE ENVIRONMENT AND SUSTAINABILITY

As the foam experts, our unique foam life cycle represents our continued commitment to the care and health of our environment and customers.

Our shop begins with selecting high quality materials to produce your customizable pieces. One of our steps in eliminating ALL waste is efficiently cutting into the foam into the shapes and sizes. The excess from

our Amoebas, Rounds, and Lily Pads, for example, is shredded and recycled for products such as carpet padding and insulation.

An additional way we care about you and our environment includes exceeding the expectations and standards in the furniture industry. We earned the Clean Air Gold Certification for our foam and fabric. This means our products have been independently tested by industry leaders for emissions into the ambient air. What does this mean for you? You can breathe easy in your workplace.





FOSTERING
CONNECTION
& **BELONGING**
IN EVERY SPACE

PRODUCTS PICTURED:
HUG CHAIR 2.0

TEXTILES PICTURED:
SILVERTEX